

STRUCTURE STABILITY UNDER MULTIPARAMETER LOADS

U. R A D O Ń

KIELCE UNIVERSITY OF TECHNOLOGY
FACULTY OF CIVIL ENGINEERING

The precritical response analysis of a structure is generally sufficient for designing purposes. However, the prediction of the response in the postcritical range is essential to identify the ability of the structure to sustain loads at large values of displacements. The modern stability analysis usually consists in generating the equilibrium path for a structure and determining its critical points, but this way is admissible only for one-parameter loads. The formal procedure allows to continue the above procedure for the multiparameter systems, although, equilibrium path should be converted into equilibrium surface or hypersurface. It must clearly be said that this method is useless for the practice due to its complexity. In the paper, the proposal of solving this problem and determining the probability of stability loss is presented.

1. INTRODUCTION

Modelling of the load acting on a structure constitutes an important part of the analysis of the problems of structural mechanics, including the stability investigations. In discrete or continuous systems, discretized by using the finite elements method, the vector of external loads \mathbf{P} can be represented in the following form:

$$(1.1) \quad \mathbf{P}_{N*1} = \mathbf{P}_{N*M}^* * \boldsymbol{\mu}_{M*1},$$

where: $\boldsymbol{\mu}$ – vector composed of M independent load parameters, \mathbf{P}^* – reference load matrix.

In the case of one-parameter load, i.e. the one changing proportionally, the formula (1.1) assumes a simpler form:

$$(1.2) \quad \mathbf{P}_{N*1} = \boldsymbol{\mu} * \mathbf{P}_{N*1}^*$$

where $\boldsymbol{\mu}$ – scalar load multiplier, \mathbf{P}^* – reference load vector.

The subject of this paper is an estimation of the effect of multiparameter loads ($M \geq 2$) on the load capacity loss resulting from node snapping of space

bar structures. Determination of limit load which corresponds to snapping points under one-parameter load, is usually effected by creating an equilibrium path in space \mathbf{R}^{N+1} (where N – number of generalized coordinates). Since the 1970 s, these problems have been often analysed and are quite well reported. At present, the best known and most reliable method of determining the equilibrium paths and analysis of critical points is the method of RIKS [1] arc length. The method of constant arc length consists in affixing an additional equation, called the constraint equation, to a set of nonlinear equilibrium equations. The hyperspace defined by the constraint equation should cut perpendicularly the equilibrium path, which will secure the best convergence of iteration. In practice, fulfilment of this condition is not possible and one has to do with a certain approximation. Riks proposed a constraint equation in the form:

$$(1.3) \quad (\dot{\mathbf{q}}_\alpha)^T \cdot (\mathbf{q} - \mathbf{q}_\alpha) + \dot{\mu}(\mu - \mu_\alpha) = (t - t_\alpha),$$

where dots denote derivatives with respect to the length of arc, \mathbf{q} – generalized coordinates vector, $t - t_\alpha$ – parameter approximating arc length.

This form of the constraint equation is discussed in many papers, e.g. by SOKÓŁ and WITKOWSKI [2, 3]. The phenomenon of node snapping corresponds to the load which is maximal in given configuration. It means that a limit point occurs on the equilibrium path. A certain indicator proposed by BERGAN and SOREIDE [4] and referred to as the current stiffness parameter is very useful in the investigation of this section.

The current stiffness parameter (CSP) is the ratio between the scaled quadratic forms of the incremental stiffness in initial and current steps, respectively.

$$(1.4) \quad \text{CSP} = \frac{\Delta \mathbf{q}^{0T} \cdot \mathbf{K}^0 \cdot \Delta \mathbf{q}^0}{\Delta \mathbf{q}^{iT} \cdot \mathbf{K}^i \cdot \Delta \mathbf{q}^i}.$$

It is a measure of changes of the stiffness matrix \mathbf{K} of the system during the motion in N – dimensional displacement space of solutions. The current stiffness parameter can have many different applications:

- estimation of the system stiffness by a changing value,
- estimation of stability of the investigated segment of an equilibrium path by checking the changing sign,
- selection of effective step length,
- control near limit points.

It should be noted that the value of current stiffness parameter tends quickly to zero when the limit point is approached. Moreover, up to the snapping instant, this parameter is contained in the interval $< 0; 1 >$ and it takes negative values for nonstable equilibrium states (Figs. 1 and 2). A formal procedure allows us to continue such an approach to multiparameter loads, but then it is necessary to

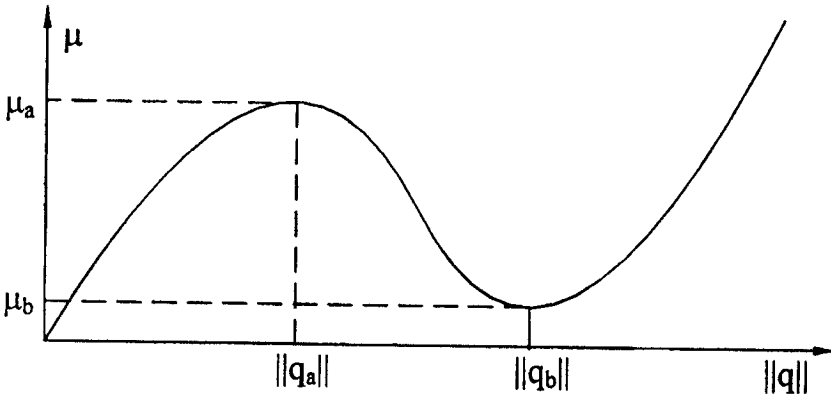

FIG. 1. Dependence of load parameter μ on the norm $\|q\|$.

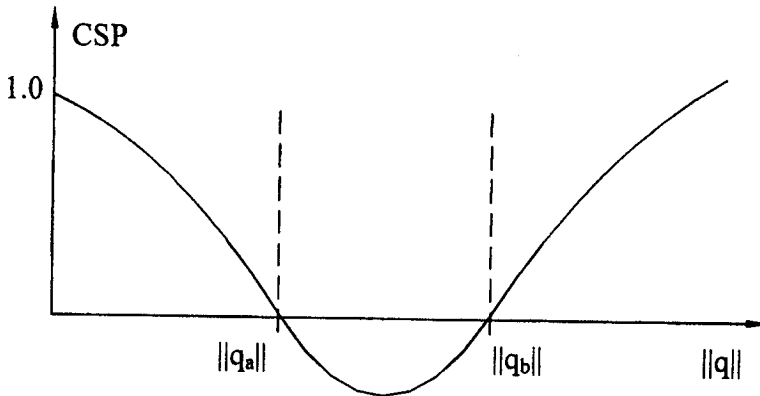

FIG. 2. Dependence of CSP parameter on the norm $\|q\|$.

calculate the area of equilibrium states and critical zones instead of equilibrium paths. Equilibrium area ($N + M$ -dimensional hyperstructure) is a locus of equilibrium points for a given set of load parameters μ_j , for $j = 1, 2, \dots, M$ in space \mathbf{R}^{N+M} , where N is the number of generalized coordinates of the system. The critical zone is in turn a locus of critical points on the equilibrium area. Calculation difficulties of building an equilibrium area are quite considerable, which causes a limited applicability of such an approach in the designed structure.

This paper presents a method of solving the problem by determining the probability of stability loss by means of simulation techniques and methods of mathematical statistics. Such an approach can be effective particularly in the analysis of nonlinear stability problems, such as node snapping. According to the present author, the proposed approach brings us closer to a practical utilization of current investigations of structure stability.

The following assumptions have been made in this paper:

- the nodes net is perfect,
- structure nodes are ideal spherical articulated joints,
- loads have a static and multiparameter character,
- actual loads are probabilistically independent,
- nonlinear geometrical and constitutive relations are taken into account.

Within the framework of these assumptions we shall determine the probabilities of stability loss by snapping in imperfect space bar structure.

2. THE CONCEPT OF A PROBABILISTIC APPROACH TO STRUCTURE STABILITY

Let us assume that random variables are the loads, whereas material-geometric data concerning the bars are deterministic quantities. Let us assume, initially, that particular loads have uniform distributions from a definite closed interval.

For illustration of this concept we shall consider a simple problem of initial stability-determination of critical force in rectangular frame with a perfectly rigid spandrel beam and columns loaded by forces μP_1^* and μP_2^* . It is therefore the problem of determining the critical value of a one-parameter load in a system with one degree of freedom (Fig. 3). The criterion of stability loss in a linearized form can be written in the form:

$$(2.1) \quad |\mathbf{K} - \mu \mathbf{G}| = 0,$$

where \mathbf{K} – linear stiffness matrix of the system, \mathbf{G} – geometrical stiffness matrix of the system, μ – load multiplier.

Stability loss will result from buckling of the frame from the initial, unstrained configuration to the strained form. The equilibrium path shown in Fig. 4 is thus a non – displacement stable path for $\mu < \mu_{cr}$, nonstable for $\mu > \mu_{cr}$, and point $\mu = \mu_{cr}$ is the point of path bifurcation.

The same problem can be solved if we assume another target. Let us determine namely the probabilities of stability loss for the values of the load parameter μ contained in the interval $\langle \mu_A, \mu_B \rangle$ in Fig. 4. This will be solved using the Monte Carlo method for sampling of load multipliers $\mu = \mu_w$ and checking the determinant sign (2.1). If the number of samplings, for which the determinant is negative is denoted by L_U , and the complete number samplings by L , the probability of stability loss is approximately equal to the frequency p

$$(2.2) \quad p = L_U/L.$$

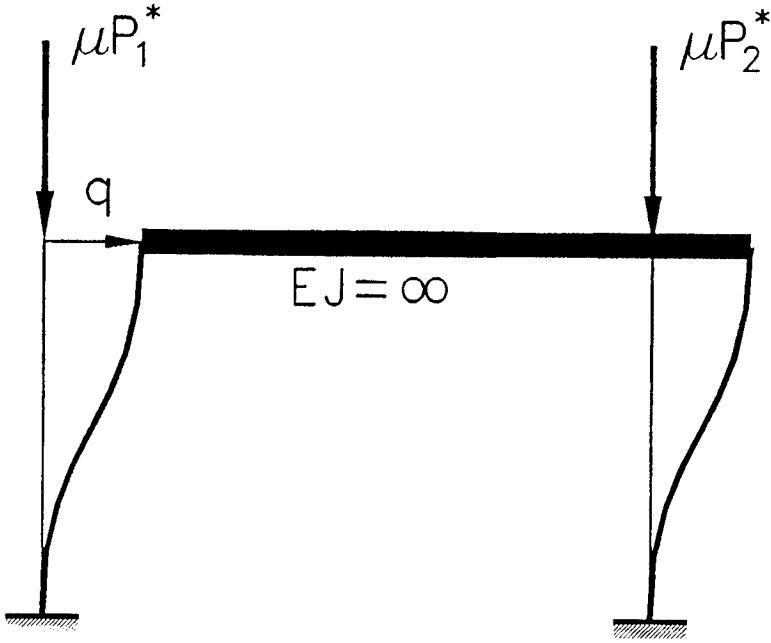

FIG. 3. The rectangular frame with a perfectly rigid spandrel beam and columns loaded with forces μP_1^* and μP_2^* .

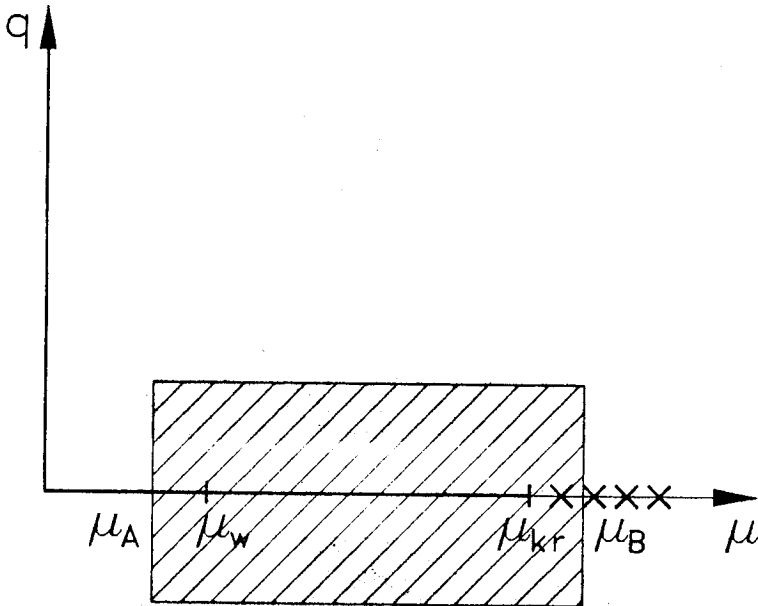

FIG. 4. Interval of load parameter μ .

Of course, for uniform distribution the probability is equal to the ratio

$$(2.3) \quad p = \mu_B - \mu_{cr} / \mu_B - \mu_A.$$

Formula (2.2) can be used in cases when the value μ_{cr} has not been determined ; therefore the above technique is certainly not competitive in this simple example. It can be different for multiparameter loads.

Let us consider once again the frame of Fig. 3, but with columns loaded by forces $\mu_1 P_1^*$ and $\mu_2 P_2^*$ (Fig. 5). This load is two-parameteric with independent

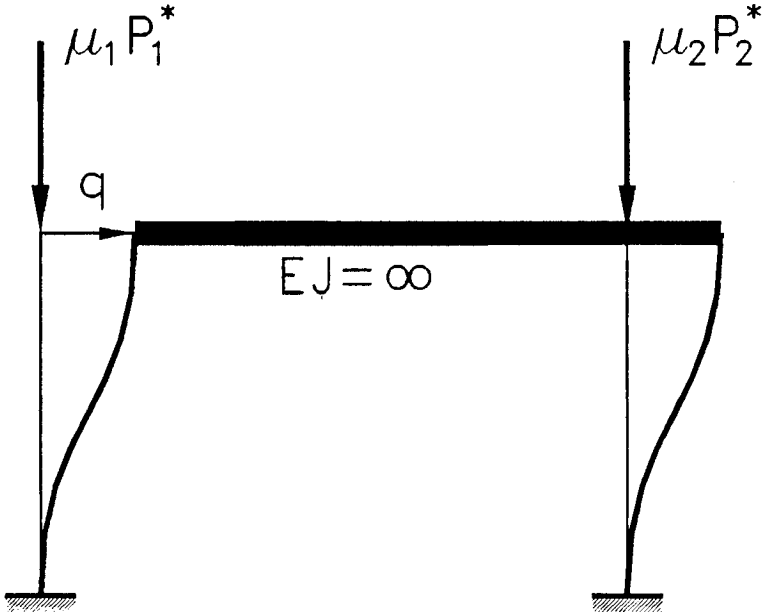

FIG. 5. The rectangular frame with a perfectly rigid spandrel beam and columns loaded by forces $\mu_1 P_1^*$ and $\mu_2 P_2^*$.

multipliers μ_1 and μ_2 . In the case under consideration, the equilibrium area in space (q, μ_1, μ_2) is a non-displacement plane (Fig. 6) on which one can determine the critical zone (boundary of the stability). It is the intersection line of the displacement equilibrium area with plane $q = 0$. In the investigation of initial stability we are interested in the stability of initial configuration, i.e. determination of the stability boundary. The method of determining this boundary is given e.g. in the monograph [5], pp. 208–211, and it consists in a multiple solution of the equation

$$(2.4) \quad |\mathbf{K} - (\mu_1 + \mu_2)\mathbf{G}| = 0$$

for the assumed different ratios μ_1/μ_2 .

As in the case of one-parameter loads, we can solve these problems many times using multipliers μ_1 and μ_2 independently and checking the determinant sign

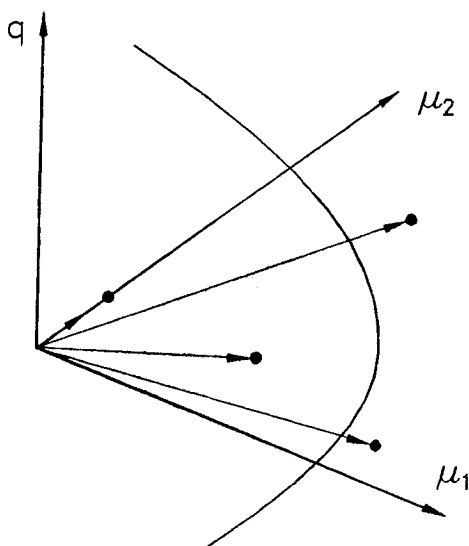

FIG. 6. The equilibrium area in space (q, μ_1, μ_2) .

(2.4). We determine the approximate probability of stability loss as previously, on the basis of formula (2.2). A similar procedure was applied in WITKOWSKI [6]. Both approaches to the problem of multiparameter loads, the direct and the simulation ones, consist in multiple solution of a quasi-one-parameter problem. Effectiveness of the simulation approach with respect to the direct approach increases together with an increase in the number of load parameters but generally, on account of the simplicity of the calculation of the determinant for linearized matrix (formula (2.4)), this concept has no considerable application to the problem of the initial stability.

3. THE PROBABILITY OF STABILITY LOSS BY NODE SNAPPING

In the investigation of the snapping problem it is necessary to determine the limit point on the equilibrium path which, contrary to that in problems described in the previous section, is a load-displacement path. In this case the criterion (2.1), (2.4) is not sufficient and it is necessary to use increment-iterative techniques discussed in Section 1.

The easiest way of illustrating the snapping phenomenon is the stability loss of the Mises truss. The construction of an equilibrium path for this truss is generally known, therefore we shall proceed to discuss multiparameter loads. Let us assume that the Mises truss is loaded in the central node by vertical force P_1 and horizontal force P_2 (Fig. 7).

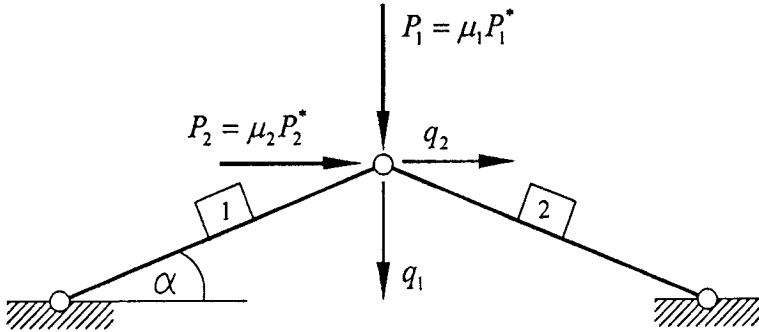

FIG. 7. The Mises truss loaded in the central node by vertical force P_1 and horizontal force P_2 . Data: $E = 205$ GPa, $A = 20$ cm², $l_1 = l_2 = 1.29$ m, $\alpha = 3^\circ$.

The vector of external loads \mathbf{P} can be represented in the form:

$$(3.1) \quad \begin{bmatrix} P_1 \\ P_2 \end{bmatrix} = \begin{bmatrix} P_1^* & 0 \\ 0 & P_2^* \end{bmatrix} \times \begin{bmatrix} \mu_1 \\ \mu_2 \end{bmatrix},$$

where μ_1, μ_2 – independent load parameters, P_1^*, P_2^* – components of the reference load matrix.

This load is two-parameteric with independent multipliers μ_1, μ_2 . Distribution of forces P_1 and P_2 is uniform. Force P_1 can assume values from the closed interval $\langle 5; 25 \rangle$ whereas the force P_2 from the interval $\langle 5, 15 \rangle$. In order to demonstrate the essence of this method we shall make only 5 samplings although, undoubtedly, this number is too small for practical applications. The following values of forces have been selected at random:

$$P_1 : [5.00; 5.63; 22.22; 9.05; 10.46],$$

$$P_2 : [5.00; 5.31; 13.61; 7.03; 7.73].$$

Coupling together the values we obtain 25 pairs of forces P_1 and P_2 . For each pair we shall solve now the following problem. For example, a pair of forces ($P_1 = 5.63$ and $P_2 = 5.31$) will be applied to the Mises truss in the way shown in Fig. 8. For such a problem we find an equilibrium path, treating it as a problem with a one-parameter load λ . Let us look for $\lambda = 1$ and CSP corresponding to this point. (Fig. 9).

We perform the presented operations for each pair of forces (in our example 25 times), i.e. we solve the quasi-one-parameter problem repeatedly simulating thereby two-parameter loads. In the case of coaxial gravity loads, the problem is reduced to finding only one equilibrium path and not, as previously, twenty-five paths. We assume $P_1^* = P_2^* = 1$. Considering again the pair of forces $P_1 = 5.63$ and $P_2 = 5.31$, the Mises truss will be loaded in the following way (cf. Fig. 10).

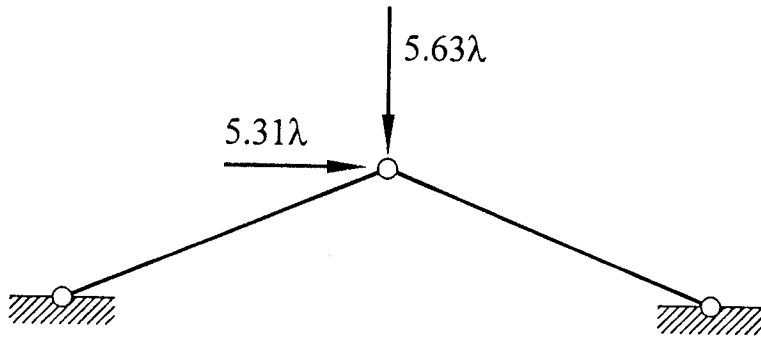

FIG. 8. The Mises truss loaded by a pair of forces ($P_1 = 5.63$ and $P_2 = 5.31$).

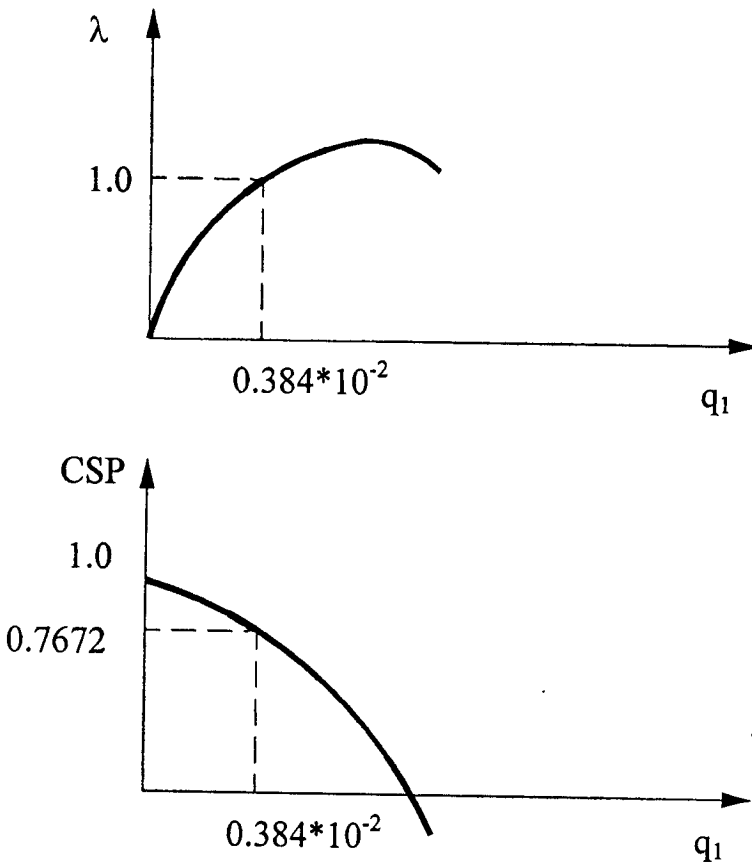

FIG. 9. Curves: load-displacement and CSP-displacement.

On the equilibrium path we find the pairs of forces selected at random and CSP values which corresponded to these points (Fig. 11).

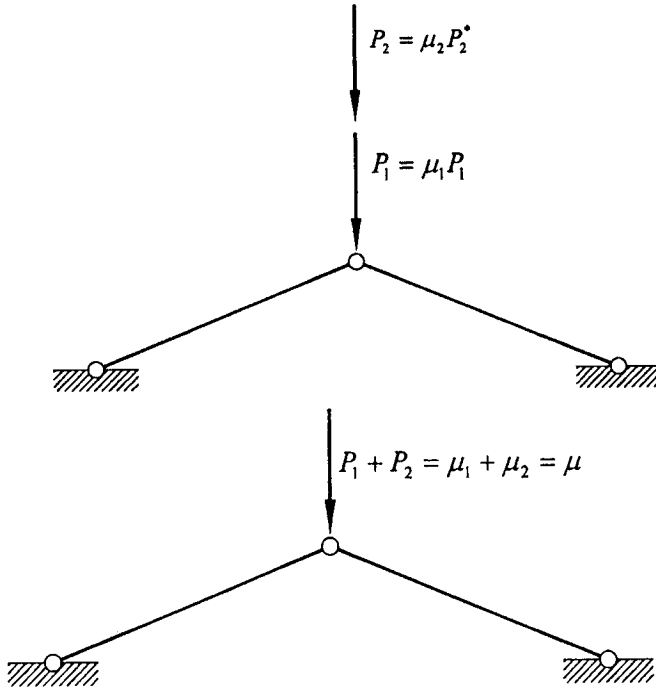

FIG. 10. The Mises truss load in the case of coaxial gravity loads.

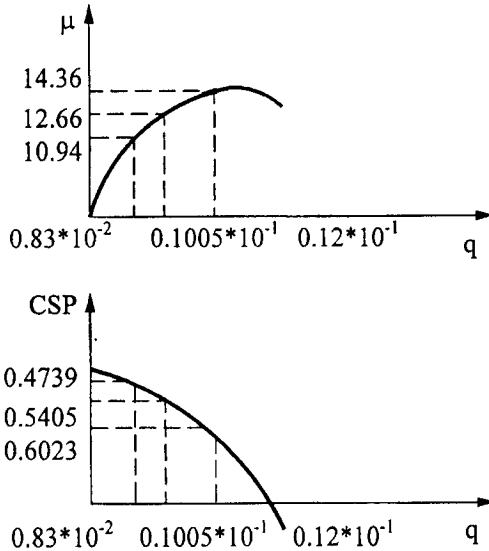

FIG. 11. Curves: load multiplier-vertical displacement and CSP-vertical displacement.

The CSP values obtained are treated as the values of a random variable. Histogram and the recorded function of the probability density of random variable CSP are obtained by the program SAS. Knowing the density function of the probability of random variable X , i.e. CSP, we can calculate the probability of stability loss by snapping in accordance with the relation

$$(3.2) \quad P(x < a) = \int_0^a f(x)dx$$

where $f(x)$ – density function of the probability of random variable X .

A question arises why the CSP was proposed as a measure of structure susceptibility to stability loss by snapping. Answering this question let us expand the potential energy of the discrete system $V = V(\mathbf{q})$ in the environment of point \mathbf{q} (equilibrium position) into the Taylor series:

$$(3.3) \quad V^* = V(\tilde{\mathbf{q}} + \delta\mathbf{q}) = V(\tilde{\mathbf{q}}) + \delta\mathbf{q}^T \frac{\partial V(\tilde{\mathbf{q}})}{\partial \mathbf{q}} + \frac{1}{2} \delta\mathbf{q}^T \frac{\partial V^2(\tilde{\mathbf{q}})}{\partial \mathbf{q}^2} \delta\mathbf{q} + 0(|\delta\mathbf{q}|^2).$$

As the first one is the equilibrium configuration, there occurs the equality:

$$(3.4) \quad \delta V(\tilde{\mathbf{q}}) = \delta\mathbf{q}^T \frac{\partial V(\tilde{\mathbf{q}})}{\partial \mathbf{q}} = 0.$$

Dependence (3.4) will now assume the form:

$$(3.5) \quad V^* = V(\tilde{\mathbf{q}}) + \frac{1}{2} \delta\tilde{\mathbf{q}}^T \frac{\partial V^2(\tilde{\mathbf{q}})}{\partial \mathbf{q}^2} \delta\mathbf{q} + 0(|\delta\mathbf{q}|^2).$$

If matrix $\frac{\partial V^2(\tilde{\mathbf{q}})}{\partial \mathbf{q}^2}$ is positive definite, the equilibrium position is stable (potential energy $V(\mathbf{q})$ achieves a proper minimum).

The necessary (but not final) condition of positive matrix $\frac{\partial V^2(\tilde{\mathbf{q}})}{\partial \mathbf{q}^2}$ definition is

$$(3.6) \quad \left| \frac{\partial V^2(\tilde{\mathbf{q}})}{\partial \mathbf{q}^2} \right| > 0.$$

This condition is relatively easy to check, but it can serve only to exclude the stability of a given equilibrium configuration. The necessary and sufficient condition of positive matrix $\frac{\partial V^2(\tilde{\mathbf{q}})}{\partial \mathbf{q}^2}$ definition is known as the Sylvester criterion:

$$(3.7) \quad W_i(\tilde{\mathbf{q}}) > 0 \quad \text{for} \quad i = 1, 2, \dots, n,$$

where $W_i(\tilde{\mathbf{q}})$ is the principal determinant of the i -th degree of matrix $\frac{\partial V^2(\tilde{\mathbf{q}})}{\partial \mathbf{q}^2}$.

Application of this criterion is time-consuming particularly in the case of the investigation of the equilibrium stability of a structure with a large number of generalized coordinates. The quadratic form standardized in respect of initial 0 or updated increment step, i.e. the CSP is decidedly easier to calculate; therefore, in the opinion of the present author, it constitutes an effective measure of sensitivity to node snapping.

4. SIMULATION OF THE MULTIPARAMETER LOADS

Loads given in standard terms and the corresponding load coefficients were determined on the basis of statistical analysis. Different loads have their specific features, hence it is not possible to assume a universal distribution:

- deadweight can be approximated by normal, or by logarithm - normal distribution;
- live load in residential and utility buildings are approximated by normal, logarithm - gamma, Gumbel's and Frechet's distributions;
- snow load is most frequently approximated by Gumbel's distribution.

In standard terms loads are characterized by two parameters: characteristic load X_k and the coefficient of loads γ_f . In accordance with ECCS/(European Specification for Steel Construction) it is assumed that characteristic value can be determined by the relation:

$$(4.1) \quad X_k = \bar{X}(1 + t_{xk}\nu_{xk})$$

where \bar{X} - mean value, t_{xk} - indicator of reliability for characteristic value, ν_{xk} - coefficient of variability for characteristic value.

The coefficient of loads γ_f is a ratio of the calculated X_d and characteristic X_k values

$$(4.2) \quad \gamma_f = \frac{X_d}{X_k}$$

Let us assume that the calculated value can also be written in the additive form:

$$(4.3) \quad X_d = \bar{X}(1 + t_{xd}\nu_{xd})$$

where \bar{X} - mean value, t_{xd} - indicator of reliability for the calculated value, ν_{xd} - coefficient of variability for calculated value.

In the paper it is assumed that

$$(4.4) \quad \nu_{xd} = \nu_{xk} = \nu_x$$

The variability coefficient can be determined from (4.1), (4.2), (4.3), and equals

$$(4.5) \quad \nu_x = \frac{\gamma_f - 1}{t_{xd} - \gamma_f \cdot t_{xk}},$$

and the mean value \bar{X} is

$$(4.6) \quad \bar{X} = X_k \cdot \frac{\frac{t_{xd}}{t_{xk}} - \gamma_f}{\frac{t_{xd}}{t_{xk}} - 1}.$$

Parameters (\bar{X}, ν_x) of distribution of the sample can be calculated in terms of another distribution type, e.g. the torque method. The load values for each load type were obtained as random numbers using successive, independent sampling. The use of the digital simulation method requires the introduction to the model of a random environment with known probability distributions. As a rule, sequences of random numbers in nonuniform distributions are required. The generally applied method of obtaining such sequences consists of two stages:

- generating a sequence of random numbers of uniform distribution,
- their transformation into numbers of a suitable distribution.

The transformation of random numbers of uniform distribution into numbers with a required distribution was based on the reverse distribution function method (WĘGLARZ, WITKOWSKI [7]).

The presented analysis was carried out for an imperfect spatial bar structure. The spatial bar structure illustrated in Fig. 13 is an example of geodesic dome. Discovery of geodesic dome was first stimulated by R. Buckminster Fuller. Fuller's studies in great circle and geodesic dome geometry were concerned primarily with dome framing in particular, with the geometry of such frames. The geodesic dome was used as covering of a sport complex at Elmira College in New York State. The 60-meter geodesic dome was erected as covering of a sport arena at St. Etienne in France. Several temcor geodesic domes have been erected in Europe, for example the dome houses of the Dutch Air and Space Museum near Amsterdam. The octahedron-tetrahedron space truss was employed in a 30-meter diameter geodesic dome erected in Detroit, Michigan in 1952. The 46-meter diameter geodesic dome was constructed in Hawaii on Honolulu's Waikiki Beach. The dome is still in use as a night club.

In the analysis, the nonlinear geometrical and constitutive relations were defined in Lagrangian description. The sources of the nonlinear relations $\sigma = f(\epsilon)$ are, apart from strictly material features, also geometrical imperfections. In this analysis, the differential constitutive relations were neglected and these were generated for the whole element (i.e. for individual bars). This approach does not

enable us to separate the material and geometrical imperfections. A real structure, e.g. a steel bar dome, is constructed using bars 2 to 4 meters long; the experiments however, were carried out using bars 163 to 572 mm long. Therefore it was of the utmost importance to interpret properly the scale effect. The solution was reached by creating a dimensionless load-displacement relation (RLD) for the imperfect compressed bar. The parameters of the RLD were derived using experimental test results presented by Sendkowski in his Ph.D. thesis [8] and SENDKOWSKI, KOWAL, RADOŃ [9]. The experiments were carried out for the flat rods of St3S steel and for a nominal cross-section 20×10 mm. The experimental data base consisted of 10 sets, each of them containing 6 to 12 test results for laboratory models of bars. In each of the experiments, 50–90 measuring points for the RLD were determined. One of the resultant curves is presented in Fig. 12. Point A indicates linear elasticity limit, B is the maximum load point, C and D points fix the limits of the curve's retreat. Statistical analysis of test results enables the selection of some properties which can be accepted as the following invariants: $P_A/P_B = 0.88065$, $\Delta_A/\Delta_B = 0.808756$, $P_C/P_B = 0.9504942$, $\Delta_C/\Delta_B = 1.10254$.

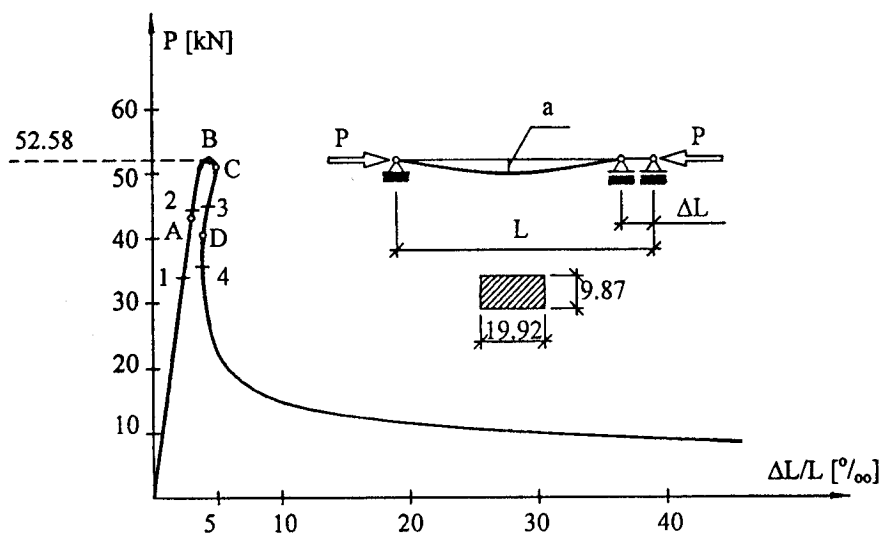
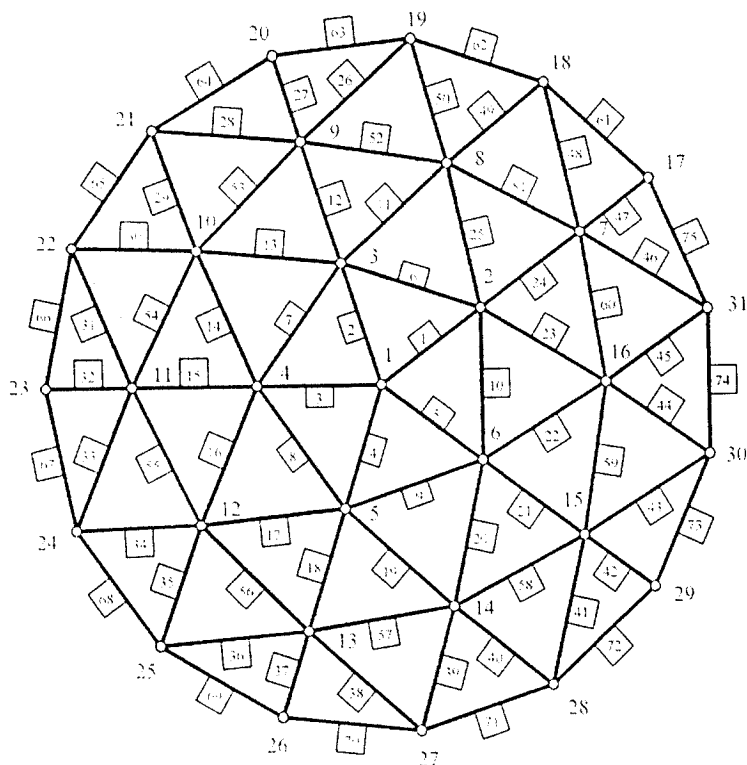
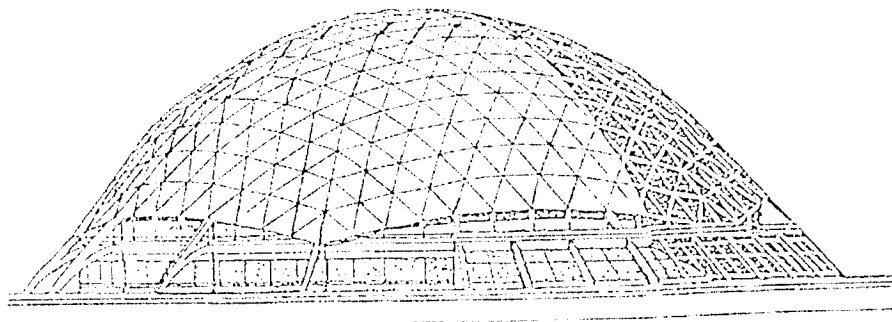

FIG. 12. Example of a RLD for a bar with imperfections.

The position of point D was found to have a very high standard deviation, therefore the effect of the curve's retreat was not dealt with. The mathematical form of the RLD was obtained using spline functions of the C^1 class. On the basis of the tests we can find that the first branch between 0 to A points can be approximated by a straight line. The tangent of the inclination angle E' is equal to $0.918E$. The next branch ABC was approximated by a polynomial of the 4th grade with the derivative at B point equal to zero. Finally, the third branch $C-\infty$

was described using the exponential function. The spline conditions at A and C points are of C^1 class. The detailed description of the procedure and the suitable formulas are contained in the paper by KOWAL, RADOŃ [10].



	x	y	z
1	0.000	0.000	9.332
2	-3.204	0.000	8.765
3	-0.990	-3.047	8.765
4	2.592	-1.883	8.765
5	2.592	1.883	8.765
6	-0.990	3.047	8.765
7	-6.407	0.000	6.785
8	-4.583	-3.330	7.416
9	-1.980	-6.094	6.785
10	1.751	-5.388	7.416
11	5.183	-3.766	6.785
12	5.665	0.000	7.416
13	5.183	3.766	6.785
14	1.751	5.388	7.416
15	-1.980	6.094	6.785
16	-4.583	3.330	7.416
17	-8.347	0.000	4.174
18	-7.397	-3.047	4.805
19	-5.183	-6.094	4.805
20	-2.579	-7.939	4.174
21	0.612	-7.977	4.805
22	4.194	-6.813	4.805
23	6.753	-4.906	4.174
24	7.775	-1.883	4.805
25	7.775	1.883	4.805
26	6.753	4.906	4.174
27	4.194	6.813	4.805
28	0.612	7.977	4.805
29	-2.579	7.939	4.174
30	-5.183	6.094	4.805
31	-7.397	3.047	4.805

FIG. 13. The spatial bar structure.

In the analysis the following data were taken into account:

- lengths of steel bars are equal to 3.254 m, 3.766 m, 3.848 m,
- the material: steel St3S,
- the indicator of reliability for characteristic value t_{xk} is equal to 2.0,
- the indicator of reliability for calculation value t_{xd} is equal to 3.5,
- the characteristic value for snow load (zone two) is equal to 0.72 kN/m²,
- the coefficient of snow load is equal to 1.4,
- the characteristic value for covering weight is equal to 0.243 kN/m²,
- the coefficient of covering weight load is equal to 1.1,
- the characteristic value for structure weight is equal to 0.782 kN/m²,
- the coefficient of structure weight load is equal to 1.1,
- the structure weight is approximated by logarithm-normal distribution,
- the covering weight is approximated by logarithm-normal distribution,
- symmetrical snow load is approximated by Gumbel distribution.

For each type loads 20 simulation tests were conducted. The statistical analysis was made by means of SAS program. The histogram of CSP is presented at Fig. 14.

In this paper, the probabilistic criterion of structure stability loss is assumed in the following form:

$$P(x \geq 0.7) = 0.9999 \quad \text{correctly designed structure.}$$

The probability values can be calculated directly from the relation (3.2), but it is necessary to determine by the SAS programme not only the type of the distribution of random variable x , but also the distribution parameters. Using certain properties of the distribution function $F(x)$ of the continuous random variable, the parameter values can be calculated in an approximate way. We can easily read from the distribution function plot, the probabilities of definite events, namely:

$$P(x, < x_1) = F(x_1),$$

$$P(x_2 < x < x_3) = F(x_3) - F(x_2),$$

$$P(x > x_4) = P(x_4) = P(x_4 < x < \infty) = F(\infty) - F(x_4) = 1 - F(x_4).$$

A value of random variable $x = x_K$, which is not exceeded by probability p is called the quantile of order p . Formally, it can be written as $F(x_k) = p$.

Using a computer program, we can read from statistical analysis the quantile values of order 1, 0.99, 0.95, 0.9, 0.75, 0.5, 0.25, 0.1, 0.05, 0.01, 0.0 and the corresponding values of random variable (Fig. 14). In the approximate method we try to "hit" the value of random variable CSP, which is near 0.7.

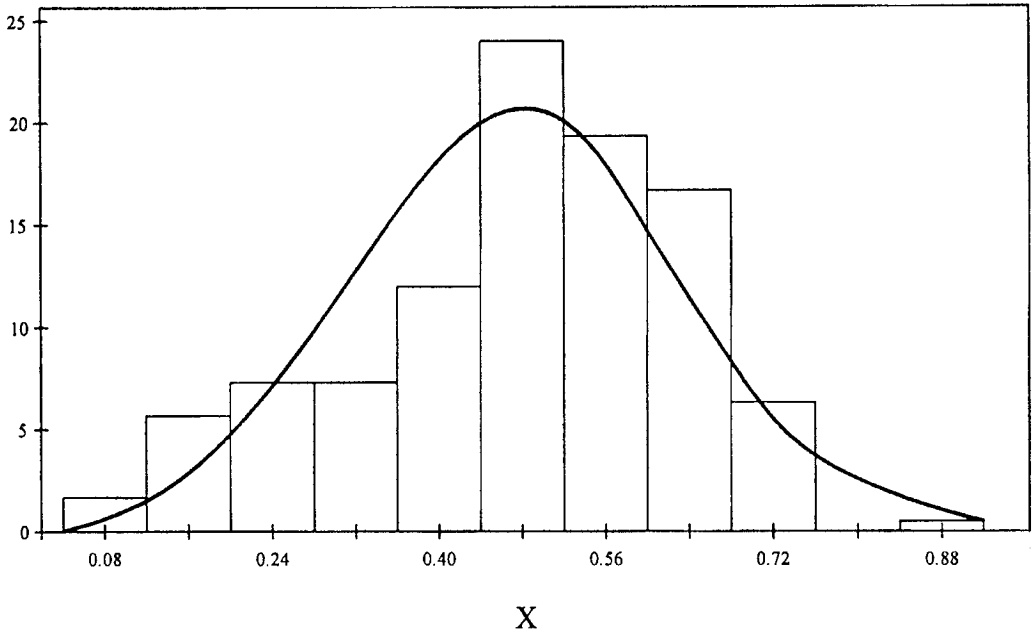

Curve: — Weibull (Theta=0 Shape=3.6 Scale=.53)

Moments

Mean	0.473438		
Std Dev	0.155036	Variance	0.024036
Skewness	-0.58572	Kurtosis	-0.29351

Quantiles(Def=5)

100% Max	0.854	99%	0.7143
75% Q3	0.5898	95%	0.6881
50% Med	0.4922	90%	0.6548
25%	0.3886	10%	0.2231
0% Min	0.0756	5%	0.1627
1%	0.1052		
Range	0.7784		
Q3-Q1	0.2012		
Mode	0.4571		

FIG. 14. Histogram of CSP.

Using an approximate method, the probability of the stability loss by snapping is illustrated below

$$P(\text{CSP} > 0.7143) = 1 - F(0.7143) = 1 - 0.99 = 0.01$$

The space bar structure was designed not correctly.

The simulation technique of multiparameter loads presented earlier enables us to obtain the information on the correctness or incorrectness of structure design from the condition of stability loss by snapping.

5. CONCLUSION

The multiparameter load of the structure can be determined by means of the mathematical apparatus, the same as that applied for one-parameter load using simulation techniques.

Use of the current stiffness parameter as the measure of the structure susceptibility to the stability loss due to snapping enables us to ascertain the correctness of the element geometry assumption.

REFERENCES

1. E. RIKS, *An incremental approach to the solution of snapping and buckling problems*, Int. J. Solids Struct., **15**, 529–551, 1979.
2. T. SOKÓŁ, M. WITKOWSKI, *The equilibrium path determination in non-linear analysis of structures*, *Advancers in non-linear finite element methods*, [Ed.] by B. H. P. TOPPING and M. PAPADRAKAKIS, Civil - Comp Press, Edinburgh 1994, pp 35–45.
3. T. SOKÓŁ, M. WITKOWSKI, *Critical states of imperfect sensitive structures*, Int. Conf, "Lightweight Structures in Civil Engineering", [Ed.] by J. Obrębski, Warsaw 1995, pp. 228–235.
4. P.G. BERGAN, T.H. SOREIDE, *Solution of large displacement and stability using the current stiffness parameter*, Conf. "Finite Elements in nonlinear Mechanics", Geilo 1977, 647–669.
5. A. GOMUŁIŃSKI, M. WITKOWSKI, *Stability of the bar structures* [in Polish], Chapter 8 of the book "Mechanics of Structures with Elements of Computer Approach", Arkady Publ., Warsaw 1984.
6. M. WITKOWSKI, *The method of space - time elements in the structural stability analysis* [in Polish], *Mechanics and Computer*, **6**, 117–132, 1986.
7. A. WĘGLARZ, M. WITKOWSKI, *Simulation method of estimation of frames stability*, 10th Polish Conf. Comp. Meth. Struct. Świnoujście, vol. **2**, 709–716, 1991.
8. J. SENDKOWSKI, *Durable limit load capacity of space trusses*, Doctor's thesis, Warsaw University of Technology, 1989.

9. Z. KOWAL, J. SENDKOWSKI, U. RADOŃ, *Equilibrium paths of space structures taking into account the real work of their elements*, 10th Polish Conf. Comp. Meth. Mech. Struct., Świnoujście, Poland, 381–388, 1991.
10. Z. KOWAL, U. RADOŃ, *Proposal of constitutive law of compressed bars determining the limit load-capacity of real structures* [in Polish], *Inżynieria i Budownictwo*, No. 12, 679–683, 1995.
11. PN-82/B-02000. *Loading of structures. Determination principles.*
12. PN-82/B-02001. *Loading of structures. Constant loads.*
13. PN-80/B-02010. *Loading in statistical analysis. Snow load.*

Received October 12, 1998; revised version May 24, 1999.
